

Features

- Bask® heated surface creates spa-like relaxation with soothing warmth on your back, shoulders and neck.
- Three heat settings allow you to customize the surface temperature.
- 120 airjets release thousands of heated bubbles that surround and support the body in a warm massage.
- Variable-speed blower lets you adjust massage intensity to 18 levels.
- Heated BubbleMassage™ includes 60-minute automatic shutoff timer.
- Two separate electronic keypad controls for Heated BubbleMassage™ and Bask®.
- Hourglass shape adds style and elegance to your bathroom.
- Integral flange helps prevent water from seeping behind wall and simplifies alcove installation.
- Bottom surface manufactured with textured appearance.
- Automatic and manual purge cycles remove residual water from air channels after use to keep the system clean.
- Right-hand drain.

Material

- Acrylic.

Technology

- Bask® technology warms the lumbar surface of the bath, delivering targeted heat to your back, shoulders and neck.
- Heated BubbleMassage™ technology warms and humidifies air before it enters the bath.

Recommended Products/Accessories

K-1446 Remote Installation Kit
K-7166-AF Bath Drain
K-24916 Wireless Music Kit



Codes/Standards

ASME A112.19.7/CSA B45.10
CSA B45.5/IAPMO Z124
ASTM E162
ASTM E662
UL 1795





**KOHLER® Hydrotherapy Components
Five-Year Limited Warranty
KOHLER® Plastic Baths and Receptors
Lifetime Limited Warranty**

See website for detailed warranty information.

Available Colors/Finishes

Color tiles intended for reference only.

Color	Code	Description
-------	------	-------------

	0	White
	96	Biscuit
	47	Almond
	NY	Dune

No change in measurements if connected with drain illustrated. (K-7272)

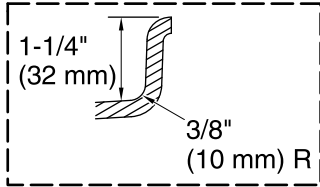

Integral Flange Detail

Blower Motor Access
30" (762 mm) W x 15" (381 mm) H Min

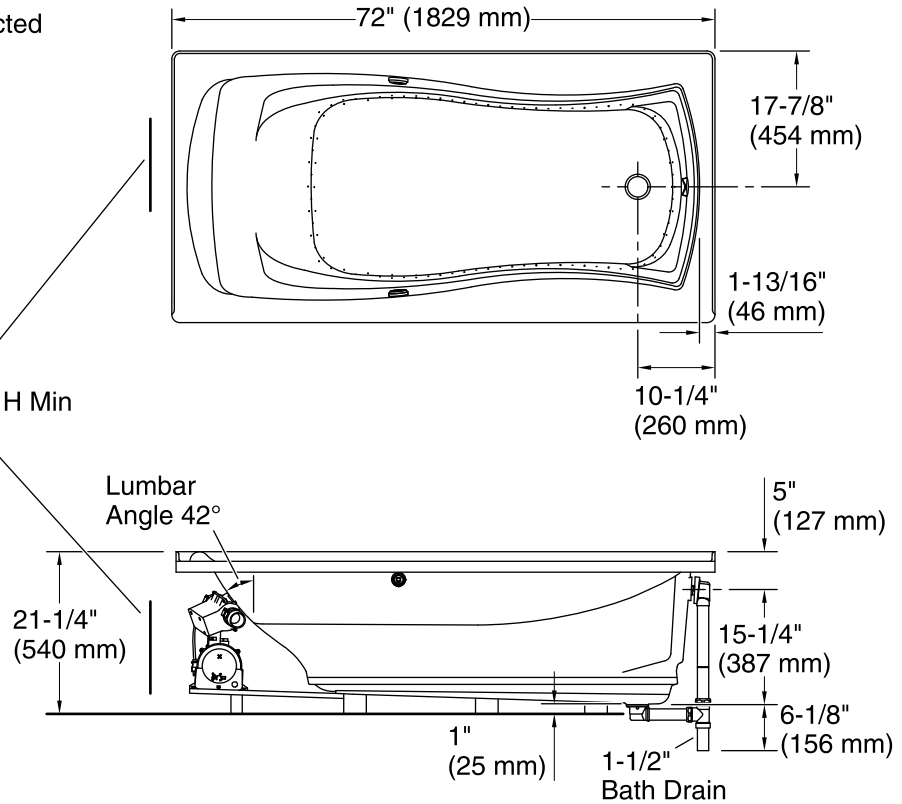
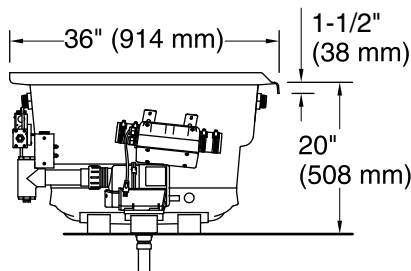

Required Electrical Service

Two dedicated circuits required, protected with Class A Ground-Fault Circuit-Interrupter (GFCI). Outside North America, this device may be known as a Residual Current Device (RCD).

Blower, Heated	120 V, 15 A, 60 Hz
Surface:	
Air bath:	120 V, 15 A, 60 Hz

Technical Information

All product dimensions are nominal.

Installation:	Three-wall alcove
Drain location:	Right
Basin area, bottom:	47-15/16" x 20-1/16" (1218 mm x 510 mm)
Basin area, top:	65-3/8" x 25" (1660 mm x 636 mm)
Weight:	114 lbs (51.7 kg)
Minimum floor load:	41 lbs/ft ² (200.2 kg/m ²)
Water depth:	13-3/8" (340 mm)
Water capacity:	72 gal (272.5 L)
Electrical component rating:	Blower: 120 V, 10 A, 60 Hz Heated Surface: 120 V, 0.5 A, 60 Hz, 65 W Air bath: 120 V, 5 A, 60 Hz

Notes

Measure your actual product for rough-in details. Install this product according to the installation instructions.

The hot water supply should be 70% of the capacity of the bath or greater. Installations will vary.

Provide one grounded electrical outlet within 24" (610 mm) of each component.

Remote blower installation kit K-1446 is available for relocating the blower. Provide access for servicing the blower.

Do not relocate or alter the PVC tee or coiled flexible tubing connected to the blower. Follow the blower relocation instructions exactly.